

# SAFE Misting®

## User guide 2025-2



**Unique misting  
management  
solutions !**

## SAFE Misting® user guide (ENG)

The SAFE Misting® control principle is distinguished by being able to lock the ON time and vary the OFF time. This achieves full control, so that moisture on furniture, floors and other surfaces is completely avoided by normal. operating conditions.



1) Pump control

2) SAFE Misting®  
1 section

3) SAFE Misting®  
2 sections



Display info for 1 section



Display info for 2 sections

### 1) Pump control:

Contains safety functions for controlling pump systems. Receives ON / OFF signals from decentralized climate computers or similar, terminal 29,30. PCB print has as an extra function to be able to start a fan clamp 7,8,9. PCB print features are not further described in this document.

### 2) SAFE Misting – 1 section:

Is a complete stand-alone pump control with display and the possibility of control via temperature / humidity sensor. ON / OFF function without sensor. Can also be used as separate control of decentralized section.

### 3) SAFE Misting – 2 sections:

Complete control of 2 pcs. separate sections equipped with ON / OFF solenoid valve and bleed-off solenoid valve for pressure relief.

The 2 sections are controlled 100% separately.

The unit sends start signal from terminal 27/28 to pump system terminal 29/30.

The 2 sections can be connected in tandem mode via the menu X21, whereby the number of starts / stops is reduced and gives less load on the pump and motor. At the same time allows to handle up to double the number of nozzles with the same pump size.

Switch between operation of sections 1 and 2 by pressing buttons 1 or 2. Display has constant display of data from both sections.

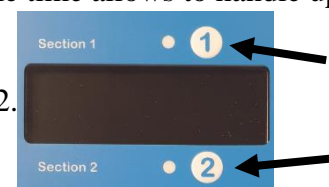

## SAFE Misting® display overview

Programs B and C require humidity sensor AMP 46

<b>LEVEL 1 - User</b>	A   ON/OFF Reg. 25°C    65%	B   Temp. reg. 25°C    65%	C   Humidity reg. 25°C    65%	D   Timer	X   Service
	A01   ON Time 10 sec	B01   Min. temp. 20°C	C01   Min. Humidity 60%	D01   Timer 1 ON/OFF OFF, ON	X01   Level select 1    2, 3
	A02   OFF Time 10 sec	B02   Max. Temp. 30 °C	C02   Max. Humidity 75%	D02   Timer 1 ON Time 08.00	X02   Show Date/Time Date                      Time
	A03   Wetting OFF, ON	B03   Fixed On Time 10 sec	C03   Fixed On Time 10 sec	D03   Timer 1 OFF Time 20.00	X03   SW version Just info
<b>LEVEL 2</b>	A11   Dust - manuel 60 sec	B11   OFF various 120 sec    max	C11   OFF various 120 sec    max	D11   Timer 2 ON/OFF OFF, ON	X11   ON Time
	A12   Disinfection OFF, ON	B12   Off Time Min 0	C12   Off Time Min 0	D12   Timer 2 ON Time 08.00	X12   Reset To Default No    Yes
	A13   Smartphone OFF, ON	B13   Max. Humidity 75%	C13   Min. temp 18°C	D13   Timer 2 OFF Time 20.00	X13   Temp unit °C    F
<b>LEVEL 3</b>	A21   Dust - Auto OFF, ON	B14   Temp. Fault Adj 0 +/-°C	C14   %rh fault Adj. 0 +/- %	D14   Timer 3 ON/OFF OFF, ON	
	A22   ON time 15 sec		C21   Various %rh OFF, ON	D15   Timer 3 ON Time 08.00	
	A23   OFF time 60 min		C22   Var. Min. temp. 20°C	D16   Timer 3 OFF Time 20.00	
	A24   Drain - auto OFF, ON		C23   Var. Max. Temp. 25°C		X21   Tandem ON/OFF OFF, ON
	A25   ON time 30 sec		C24   Var. Change %rh 10%		X22   Max. ON time 120 sec
	A26   OFF time 8 hour				
	A27   Bleed off - Auto OFF, ON				

## Operating instructions for the SAFE Misting® controller



OK and "Enter". Opens the main menu and is used to confirm the entered selection.

When starting up the Safe Misting® controller in AUTO. Press the "Enter" button within approx. 2 seconds. Hereafter the menu is locked, and the system does not start its routine. When the settings are as desired, the system must be restarted.



Return and "Backspace". Used to step back in the menus.

When the control is fully returned, the control is back at the output program e.g. program A, B or C.

With right/left arrow keys   the cursor can move position for change in values.

Up/down arrow keys   used for maneuvering in the program, including changing values.

By pressing the right / left arrow key at once   initiates a fast dust reduction function A11.

Example:

```
A ON/OFF Reg.
B Temperature Reg.
→C Humidity Reg.
D Timer
```

```
→C01 Min. Humidity.
C02 Max. Humidity
C03 Fixed On Time
```

```
C01 Min. Humidity.
                                050.0%
```

By pressing the left arrow key approx. 5 sec.  the NTC temperature on pump + ON time for pump / system is displayed.

```
1:NTC: 39.6°C
1:On: 11h
2:NTC: 0.0°C
2:On: 12h
```

Quick info – left arrow key

```
Main board: 45h
Board 1: 11h
Board 2: 12h
Restarts: 32
```

ON time in menu X11

### Level 1 – User:

Normal user level with as few setting options as possible.

In normal use, there are only 3 program types to choose from. - (A, B, C)

```
A ON/OFF Reg.
B Temperature Reg.
→C Humidity Reg.
D Timer
```

### Level 2:

Activated in the menu X01.

Is for users who want to set more specific features.

**Level 3:**

Activated in the menu X01.

More special functions for automatic and variable temperature control and operation.

**There is a total of 5 main menus (A,B,C,D,X), of which 3 different program forms (A,B,C):**

- A: ON / OFF control      - Simple control without temperature / humidity sensor.
- B: Temperature control    - Requires temperature / humidity sensor.
- C: Humidity control       - Requires temperature / humidity sensor.
- D: Hours                    - Able to overrule when the system can run.
- X: Service                  - Various service functions.

**General function:**

If the unit is left without approving / exiting the current menu item, the control returns after 15 minutes to the program area that was last activated.

Including both "Level 2 and 3", as well as menus A, B or C in the main menu.

**When actual program changes have been made, etc. (does NOT apply to simple changes of values) - switch off both sections (disconnect completely from the power) and start up again.**

**After this, the program is activated and ready for operation.**

## A: ON/OFF regulation:

Is a program with "simple" ON / OFF functions without the use of temperature or humidity sensors. Very suitable if 100% manual control of the humidification is desired, e.g. in open buildings etc. The function is also suitable for dust suppression and soaking.

**A01) ON Time:** Default set to 10 sec.

**A02) OFF Time:** Default set to 10 sec.

**A03) Wedding:** Default set to OFF.



Wedding is soaking. When ON is selected, the system runs until it is stopped, or the 24-hour clock stops.

If it is a system with several separate sections, you must be aware that there must be a consumption of at least 20% of the pump's max. performance as less consumption can result in overheated pumping system, and thus extensive consequential damage.

However, this will require pump temperature control such as AMN 23.

Wedding is covered by the 24-hour clock and the safety functions in the program, thus achieving a safer soaking than with manual operation for soaking.

**A11) Dust, Manuel:** Default set to 60 sec.

This is a dust suppression function that works by briefly pressing right/left arrow keys at once  , after which the system goes into ON for the given set period.

In practice, this means that dust can be reduced immediately before work in the section, which provides a better dust-reduced climate during the stay in the section.

If you press  the function is "cancelled" and the function will stop.

**A12) Disinfection:** Default set to OFF.

If the value is ON here, the function starts and program A, B, and C will be disabled.

Program A24 Drain – Auto can be activated.

Program D with the timer function can still be used.

This function is used to disinfect indoor areas where airborne viruses like Covid and flu are likely to spread.

Activate the function by pressing , and set the wanted time in menu A11).

To stop the function again press  and cycle will stop.

The complete ON time for operation is set in menu A11) – Typically 3 minutes.

ON time for actual mist period is set in menu A01) – Typically 7 to 10 seconds.

OFF time for actual mist period is set in menu A02) – Typically 10 to 20 seconds.

**A13) Smartphone:** Default set to OFF.

If the value is ON:

When power is connected to the device - via mobile device - the application A12) starts up as if you were pressing the up arrow. When it is finished and if there is still power on – It is operated as usual.



**A21) Dust - auto:** Default set to OFF

If the value is ON here, it means that it "automatically" initiates a "simple" ON / OFF operation when the system has not been running for the set period. Used to automatically initiate dust suppression function.

Can also be used as a nozzle humidifier in a way so that the nozzle tips avoid drying out - e.g. 5 sec. pr. ½ hour. Values are set in menus A22 and A23.

**A22) ON Time:** Default set to 15 sec.

**A23) OFF Time:** Default set to 60 min.

**A24) Drain - auto:** Default set to OFF

If the value is ON here, it means that it "automatically" initiates a "simple" ON / OFF operation when the system has not been running for the set period.

Used to automatically initiate flushing of systems e.g., every 6 hours to avoid Legionella etc. - drain valve must then be mounted at the end of the pipeline.

The special thing here - that the bleed-off valve is 100% open throughout the operating period to flush the system - Activation of A24 means that the drain-valve (bleed-off) 10,11,12 is activated at the same time as starting 13,14, 15 (pump / solenoid valve). Values are set in menus A25 and A26.

This function can only be activated in decentralized controllers where terminal 25,26 is shorted at pcb which disables the pressure switch.

If function is requested for 1 section directly on the pump system, it is necessary to disable the pressure switch function.

**A25) ON Time:** Default set to 30 sec.

**A26) OFF Time:** Default set to 6 hours.

**A27) Bleed-off - auto: Default set to OFF**

When this function is used, **A24) Drain – auto** must be set to OFF.

If the value is ON here, it means that it “automatically” initiates a “simple” ON/OFF operation of ONLY the bleed-off valve for pressure relief in the pipe string, when the system has not run for the set period.

Used to automatically depressurize the pipe string, e.g. every 6 hours to remove any pressure in the pipe, which could otherwise cause inappropriate dripping from the nozzles.

Values are set in menus A25 and A26.

This function can only be used in decentralized controls, where terminals 25,26 are short-circuited and therefore the pressure switch function is out of operation.

If this function is required for one section directly on the pump system, the pressure switch function must be disabled.

## B): Temperature regulation:

Is a program based on temperature sensor that can be placed both inside the building and outside the building as desired and needed.

Automatically varies the amount of cooling depending on the temperature.

The control itself is a "simple" PI control that follows the temperature and accelerates up, directly in proportion to the rise in temperature.

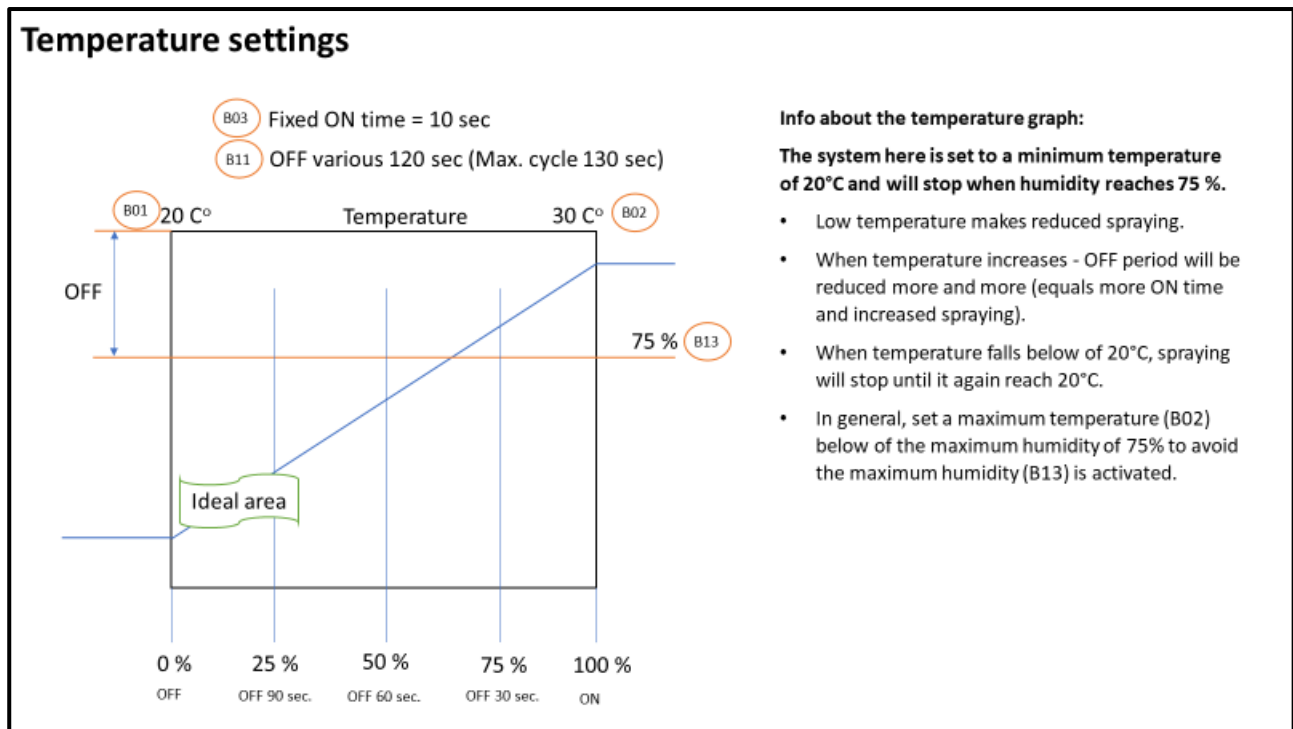

**B01) Min. temp.:** Default set to 20°C.

Sets the minimum temperature at which the system starts cooling. Below this set temperature, the system stops.

**B02) Max. temp.:** Default set to 30°C.

Sets the maximum temperature.

Above set max. temp. running the system all the time.

It is between B01) and B02) the temperature is regulated.

Adjusted slowly with a large distance between the 2 points and quickly at a small distance.

**B03) Fixed ON Time:** Default set to 10 sec.

Here you set the desired ON time.

If the nozzles are in - or above an air flow, this function is not essential and can be set up significantly so as not to give the system more start / stop than necessary. Continue with the focus on the ON time normally having to be stopped before moisture and "cold" is felt in the living zone. Without airflow, time is observed from ON start until the water mist is in the occupancy zone. IS very temperature and height dependent + nozzle size is significant. Typical ON time will be 5 to 15 sec.



**B11) OFF Various:** Default set to 120 sec.

Here the max OFF time is set. This means that when the temperature is above the lowest set value, the system runs its ON time and then stops for a maximum OFF time of 120 sec. (default). When the temperature is in the middle of the range, e.g. 25° C, the OFF time is reduced to 60 sec. When the temperature has reached the maximum, the OFF time is reduced to 0 and the system runs all the time.

(on the bottom board, the function is set to a minimum of 5 sec. ON and a minimum of 5 sec. OFF to avoid quick start / stop of the engine - which can overheat the engine and damage it)

**B12) Off time min:** Default set to 0 sec.

Used if 100% operation of the system is NOT desired. Perhaps oversized number of nozzles with the possibility of avoiding too much moisture in the occupancy zone.

**B13) Max. Humidity:** Default set to 75%.

Is a simple function for stopping the system if the humidity level becomes too high.

**B14) Temp. Fault Adj.:** Default set to 0.

Temp. Fault, has the function of being able to correct an error display. If the existing climate computer shows 2 degrees more than this, the temperature can simply be adjusted visually so that the values match. (corrects temperature / humidity signal from sensor).

### C): Humidity regulation:

The program is based on an external moisture sensor, which can be placed both inside and outside the current section as desired and needed.

Varies automatic cooling and humidification depending on the humidity level.

The regulation itself is a "simple" PI regulation that follows the moisture content and accelerates up, directly in proportion to the decrease in the moisture level. (lower value increases spray capacity). This is the function that provides the optimal cooling function and saves maximum on the air extraction and thus the power consumption during ventilation. At high outdoor temperatures, it is really only cooling that can reduce the temperature inside.

In winter, when the system is used for humidification (for dry air), there must be a focus on the fact that increased ventilation may require significant additional heating of the incoming air.

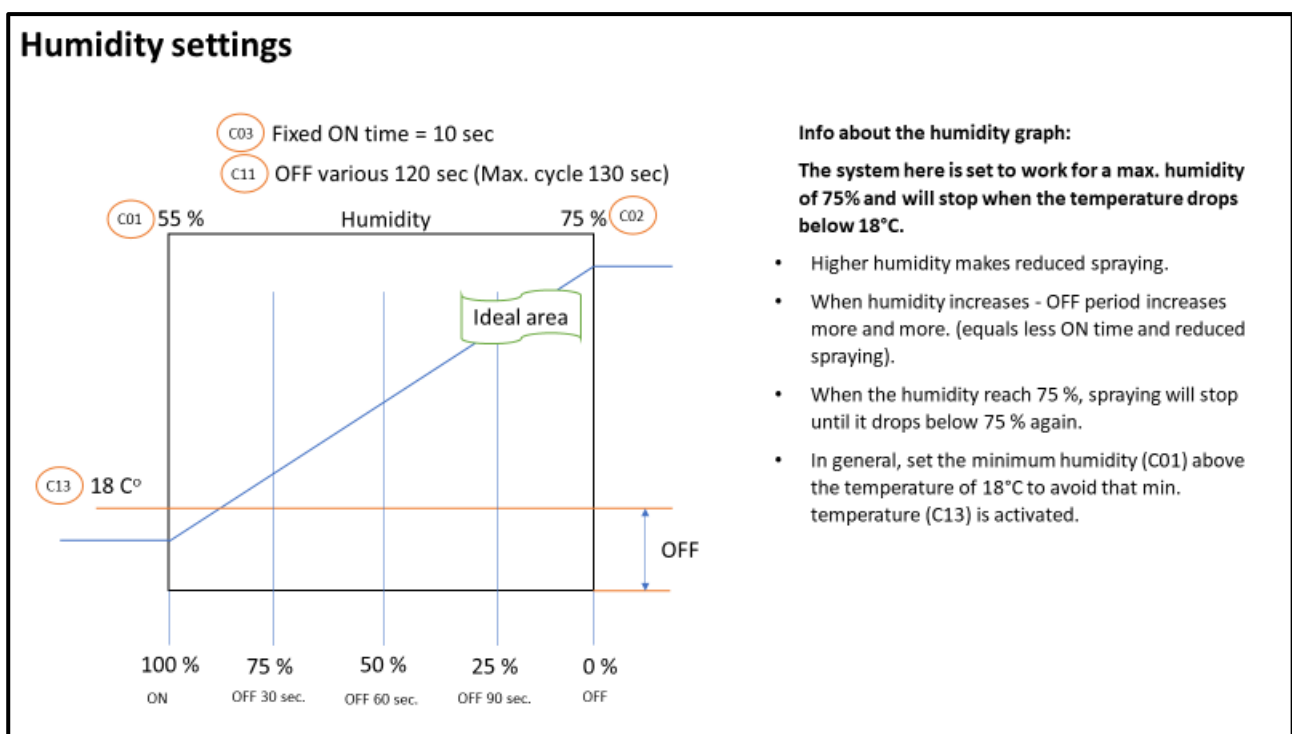

**C01) Min. Humidity:** Default set to 60%.

Sets the minimum humidity level where the system runs 100%. (below minimum humidity (60%) the system runs 100% to increase the humidity level)

**C02) Max. Humidity:** Default set to 75%.

Sets the maximum humidity level.

Above set max. moisture stops the system.

It is between C01) and C02) the moisture level is regulated.

Adjusted slowly with a large distance between the 2 points and quickly at a small distance.

**C03) Fixed ON Time:** Default set to 10 sec.

Here you set the desired ON time.

If the nozzles are in - or above an air flow, this function is not essential and can be set up significantly so as not to give the system more start / stop than necessary. Continue with the focus on the ON time normally having to be stopped before moisture and "cold" is felt in the living zone. Without airflow, time is observed from ON start until the water mist is in the occupancy zone. IS very temperature and height dependent + nozzle size is significant. Typical ON time will be 5 to 15 sec.

**C11) OFF Various:** Default set to 120 sec.

Here the max OFF time is set. This means that when the humidity level is above the lowest set value, the system runs its ON time and minimal OFF time. When the moisture level is in the middle of the area, e.g. 65%, the OFF time is reduced to 60 sec. When the moisture level has reached max, the OFF time is increased to max. In 120 sec. and thus minimum humidity just before the plant stops completely.

**C12) Off time min:** Default set to 0 sec.

Used if 100% operation of the system is NOT desired. Perhaps oversized number of nozzles with the possibility of avoiding moisture in the occupancy zone.

**C13) Min. Temp.:** Default set to 18°C.

Is a simple function for stopping the system if the temperature becomes too low.

**C14) %rh Fault Adj.:** Default set to 0.

Humidity level error - has the function of being able to correct an error display.

If the existing climate computer shows 2% rh more than this, the humidity level can simply be visually adjusted up or down so that the values match. (corrects temperature / humidity signal from sensor).

**C21) Various %rh:** Default set to OFF

Here you can switch a special automatic humidity control on or off.

With this program area, min. and max. values for moisture content, which are "automatically" drawn up and down as needed, so that when it is "cold", it is cooled up to a low moisture level and when it is hot, it is cooled up to a higher moisture level, whereby it is possible to completely automatically set the optimal moisture level depending on the temperature.

75% moisture may be too high for optimal production, but better than a high temperature, so a high moisture content can be OK when it is really hot. Conversely, it is not desired to start cooling before necessary if it is colder. Therefore, the humidity level is lowered at a lower temperature.

With moisture control, it is the opposite. High temperature requires low moisture content. This will also be the optimal for normal well-being for humans and animals. Means that the value in C24 can be both positive and negative.

**C22) Var. Min. Temp.:** Default set to 20°C.

Sets the minimum temperature for this special function.

**C23) Var. Max. Temp.:** Default set to 25°C.

Sets max. temperature for this special function.

**C24) Var. Change %rh:** Default set to 10%.

Sets the amount of moisture the values must be adjusted depending on the temperature. Adjusts the values in C01) and C02). Change can be both positive and negative.

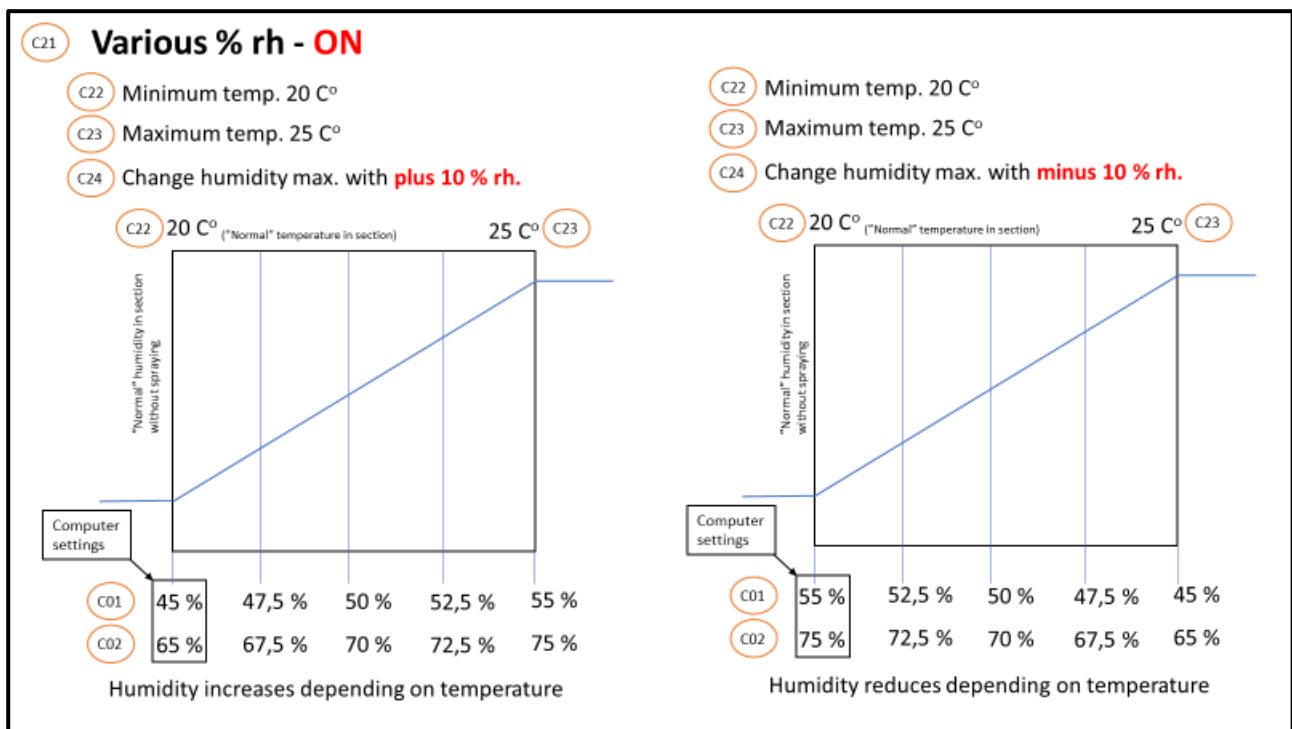

**D): Timer:**

Setting of 24-hour clock.  
 Overrides all other functions.

- D01)** Timer 1 ON / OFF: Default set to OFF.
- D02)** Timer 1 ON Time: Default set to 8.00.
- D03)** Timer 1 OFF Time: Default set to 20.00.
  
- D11)** Timer 2 ON / OFF: Default set to OFF.
- D12)** Timer 2 ON Time: Default set to 8.00.
- D13)** Timer 2 OFF Time: Default set to 20.00.
  
- D14)** Timer 3 ON / OFF: Default set to OFF.
- D15)** Timer 3 ON Time: Default set to 8.00.
- D16)** Timer 3 OFF Time: Default set to 20.00.

**X): Service:**

Contains several functions and information that are not normally used in everyday life.  
 When, and if X mode has been opened but not used for more than 15 minutes, the system itself returns the last used main menu A), B) or C).  
 Also applies to all other positions that are left automatically after 15 minutes and return to the last used user level if you have not manually returned to the desired user level.

- X01) Level Select:** Default set to 1.  
 LEVEL 1 – Sets and displays daily user settings.  
 LEVEL 2 – Sets and displays special values for general practical use.  
 LEVEL 3 – Sets and displays more advanced values.

**X02) Show Date/Time:** Time is displayed and set here.

**X03) SW Version:** Display only. Cannot be set or corrected.

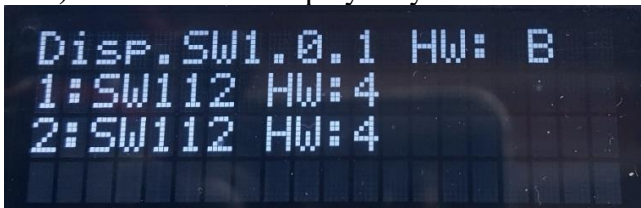

Info in LEVEL 1 (X03)



Info in LEVEL 3 (X03)

**X11) ON Time:** Display only. Cannot be set or corrected.  
 Shows the number of hours the system has been in operation.

**X12) Reset To default:** Default set to No.  
 Allows reset of all values to original default values - incl. timers - but excl. clock.

**X13) Temp. unit:** Default set to °C.  
 Can be changed to Fahrenheit.

**X21) Tandem ON/OFF:** Default set to OFF.

Is only relevant for decentralized operation of 2 sections. (AMP-45).

Default OFF means that 2 sections run 100% independently of each other.

Switching to ON, the 2 sections are interdependent.

If a section goes ON, it starts as normal. If the second section sends an ON signal while the first section is in ON, section two goes into standby mode.

When section 1 is OFF it momentarily switches to section 2, so that the pump does NOT stop.

Section 2 runs its full cycle.

If there is no ON signal - both sections are OFF until a new ON signal arrives.

It will be random if section 1 or 2 comes first.

If one section becomes a little behind with cooling, the ON signal comes earlier and thus catches up with its needs.

**X22) Max. ON time:** Default set to 120 sec.

If one of the sections gets in a 100% ON situation, conflicts will arise and therefore are X22 default set to 120 sec.

After 120 sec. an automatic change is made to the other section if this is in the standby position. If not, the current section continues in ON.

This ensures that both sections are always given operational priority.



## Wire connection of the SAFE Misting® controller

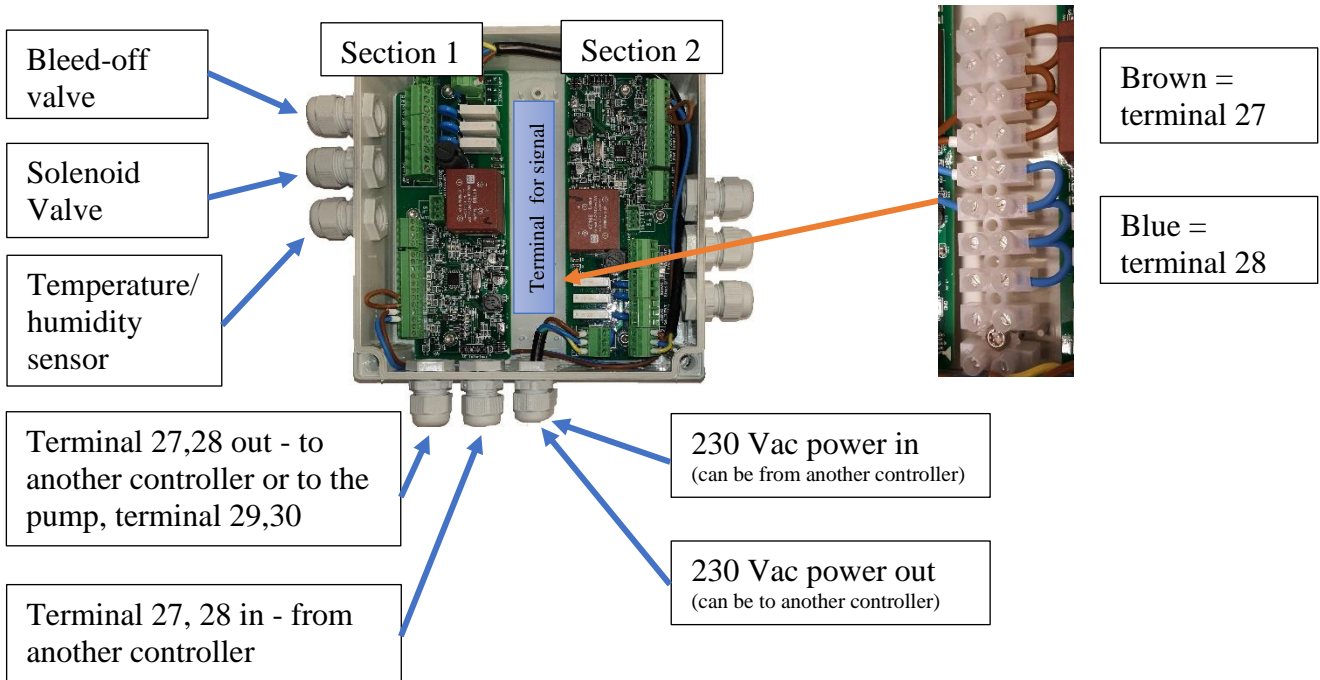

Back side of the display front

Connection of the wire to the bottom PCB.

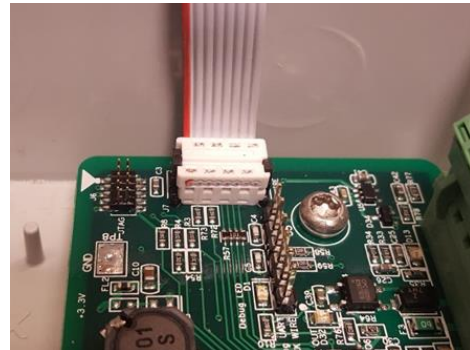
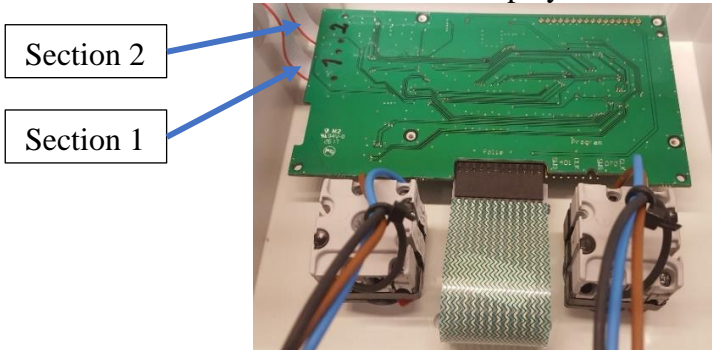

Battery can be changed when the clock stop working (after maybe 10 years).

Battery 3 Volts CR2025 – diameter Ø20 mm – height 2,5 mm

